

# Tube Fabricating Equipment

*Catalog 4290  
Revised, August 2003*



## Introduction

At Parker, we feel that proper tube selection and installation are key ingredients to building leak-free, reliable tubing systems. Displayed in this catalog is a full compliment of tube cutting, deburring, bending, and assembly equipment for use in installing stainless steel and copper tubing systems.

Dedication to quality at Parker is second to none. Our resources and vast product line, supported by an ISO 9000 Certified Quality Management System, is available through our worldwide distribution network. For more information regarding our tube fabrication equipment and other products and services, please contact your authorized Parker Instrumentation Distributor or call 1-800-C-Parker today.

## PRODUCT INDEX

### BENDERS

PG. 4



HAND TUBE BENDERS

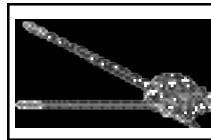

1" HAND TUBE BENDER

### CUTTING & DEBURRING TOOLS

PG. 5

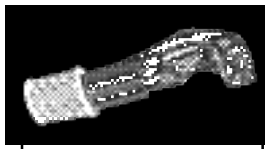

STAINLESS STEEL CUTTER



MINI-TUBE CUTTERS

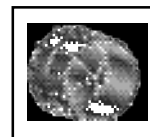

IN-EX DEBURRING TOOL

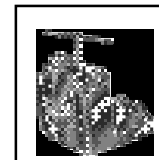

TRU-KUT SAWING VISE

### ASSEMBLY TOOLS

PG. 6

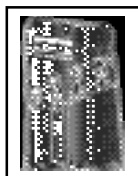

PAR-LOK WRENCH KIT



INSTRUMENTATION FERRULE PRESETTING TOOLS



IPD FERRULE PRESETTING TOOL KIT



ROTARY WRENCH

### GAUGEABILITY TOOLS

PG. 10

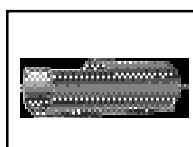

TUBE MARKER

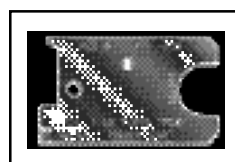

INSPECTION GAUGE



GAP GAUGE

### TECHNICAL INFORMATION

PG. 10

- INSTRUMENTATION TUBE FITTING VIDEO TRAINING PROGRAM ..... PG. 10
- PARKER HANNIFIN TUBE FABRICATION SAFETY SEMINAR ..... PG. 10
- INSTRUMENT TUBING SELECTION GUIDE ..... PG. 11-12
- MAXIMUM ALLOWABLE WORKING PRESSURES TABLE ..... PG. 12-14
- HAND BENDER CAPACITY GUIDES ..... PG. 15
- HAND CRANK AND HYDRAULIC TUBE BENDER CAPACITY GUIDES ..... PG. 15-16

### ASSEMBLY, REMAKE & GAUGEABILITY INSTRUCTIONS

PG. 17

- ASSEMBLY AND REMAKE INSTRUCTIONS ..... PG. 17
- GAUGEABILITY ASSEMBLY INSTRUCTIONS ..... PG. 17
- TUBE FITTING AND TUBE FABRICATION EQUIPMENT ..... PG. 18

### HUNTSVILLE, AL PLANT



#### WARNING

FAILURE, IMPROPER SELECTION OR IMPROPER USE OF THE PRODUCTS AND/OR SYSTEMS DESCRIBED HEREIN OR RELATED ITEMS CAN CAUSE DEATH, PERSONAL INJURY AND PROPERTY DAMAGE.

This document and other information from Parker Hannifin Corporation, its subsidiaries and authorized distributors provide product and/or system options for further investigation by users having technical expertise. It is important that you analyze all aspects of your application and review the information concerning the product or system in the current product catalog. Due to the variety of operating conditions and applications for these products or systems, the user, through its own analysis and testing, is solely responsible for making the final selection of the products and systems and assuring that all performance, safety and warning requirements of the application are met.

The products described herein, including without limitation, product features, specifications, designs, availability and pricing, are subject to change by Parker Hannifin Corporation and its subsidiaries at any time without notice.

#### Offer of Sale

The items described in this document are hereby offered for sale by Parker Hannifin Corporation, its subsidiaries or its authorized distributors. This offer and its acceptance are governed by the provisions stated in the "Offer of Sale".

© Copyright 2003, Parker Hannifin Corporation. All Rights Reserved.

## Benders

### Hand Tube Benders

These are sturdy, easy-to-use hand tools for fast and accurate bending without kinks or visible flattening. Individual sizes in four models from size -2 (1/8" O.D.) to -16 (1" O.D.) and 5mm to 25mm are available.

### Medium Duty Inch and Metric Hand Tube Benders

**Base Part No. 2829**

***Designed and built for fast, accurate bends and long service life.***

These are individual benders for eight inch tube sizes (1/8", 3/16", 1/4", 5/16", 3/8", 1/2", 5/8", 3/4") and six metric sizes (5mm, 6mm, 8mm, 10mm, 12mm, and 14mm). Will bend copper, aluminum, annealed steel and stainless steel. Can be used in hands or mounted in a bench vise. Simply align marks on slide block and radius block then bend to desired angle (up to 180°) by pulling steadily on slide block handle. Angles are indicated on radius block, both front and back. (Detailed instructions are included with each bender.)

See Table N2, on page 15, for inch part numbers and technical data.

See Table N3, on page 15, for metric part numbers and technical data.

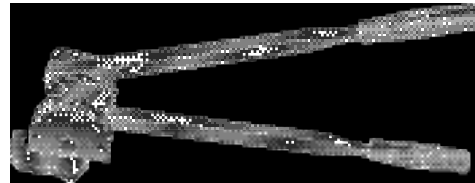

**Medium Duty Bender, 2829S**

### 1" Hand Tube Bender

**Part No. 16-2829**

For tubing size 1" O.D. in soft copper and aluminum. Can be used in hands, but suggest mounting on bench vise — especially for heavier wall thickness tube. Align marks and bend tube to desired angle (up to 180°) by pulling steadily on operating handle. Handle may be re-positioned for maximum leverage. Angles are indicated on radius block. (Detailed instructions are included with bender.)

See Table N2, on page 15, for technical information.

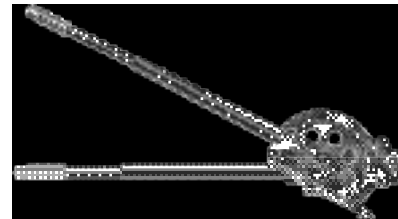

**1" Tube Bender, 16-2829**

### Cutting & Deburring Tools

#### Stainless Steel Tube Cutter

Here they are, the instrumentation tools you have been asking for. The new Instrumentation Tube Cutter is designed for use on stainless steel tubing, as well as steel, aluminum, and copper.

The Parker Instrumentation Tube Cutter – part number #635B-EX Tube Cutter – has a built in I.D. deburring device and comes with an attached spare cutter wheel. It is for tubing sizes 4 (1/4") to 24 (1-1/2"). Replacement cutter wheels can be ordered.

Orders for these instrumentation tools can be placed through Parker IPD in Huntsville, ask for price list 4390-ICD Addendum B.

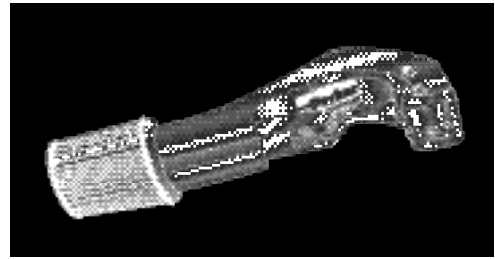

Stainless Steel Cutter

#### Tube Cutter

##### Part No. 635-B-EX Tube Cutter-2

For tubing sizes 4 (1/4" O.D.) to 24 (1-1/2" O.D.) frame.

#### Mini-Tube Cutter

For those customers working in tight areas or with small size tubing, our Mini-Tube Cutter is the answer. It will work in close spaces on tubing from 1/8" to 5/8". It will work on all materials and the cutter wheel is replaceable.

For tubing sizes-2(1/8" O.D.) to 10 (5/8" O.D.)

#### Replacement Parts for Tube Cutters

Cutter Wheel for No. 635-B-EX Tube Cutter-2

Cutter Wheel for No. Mini-Tube Cutter



Mini-Tube Cutter

#### In-Ex® Tube Deburring Tool

##### Part No. 226-SS

A quick twist of the wrist will deburr either the O.D. or the I.D. of the tube end. Parker's In-Ex deburrer can be used on the annealed steel, stainless steel, copper and aluminum, for tube sizes 1/8" to 1-5/8" O.D.

Insert tube into the convexed end of the In-Ex for inside deburring and the opposite end for outside deburring. Rotate in either direction. Replacement blades can be ordered.

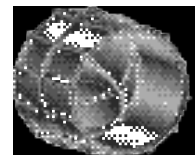

In-Ex® Tube Deburring Tool

#### Replacement Blades

##### Part No. 226SS Blades

#### Tru-Kut® Sawing Vise

##### Part No. 710439

Hacksaw guide will accommodate tube, pipe and hose from sizes 3 (3/16" O.D.) to 32 (2" O.D.). Assures square cut-offs within  $\pm 1^\circ$ . Use a fine tooth hacksaw blade for smoother cuts.

**How To Use:** Mount in vise or bolt to bench. Clamp tubing, pipe or hose into the Tru-Kut vise and cut off; guide ensures accurate square cuts.

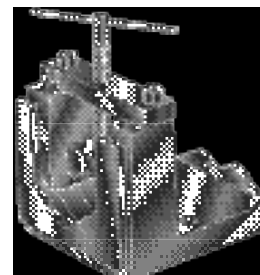

Sawing Vise

## Assembly Tools

### Par-Lok Wrench Kit

The Par-Lok Wrench Kit includes four 360° snap-action ratchet wrenches that allow fitting installation in tight, hard-to-access locations. Par-Lok wrenches are designed for tightening 7/16, 9/16, 11/16, and 7/8-inch hex nuts (for use with No. 2, 4, 6, and 8 size instrumentation tubing). The wrench handles have the make-up instructions on them. The wrenches are packaged in a handy vinyl pouch.

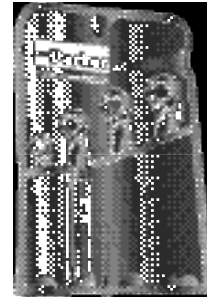

Par-Lok Wrench Kit

## Instrumentation Hand Pre-Setting Tools

### Ferrule pre-setter (sizes 2 to 16)

Fitting Size	Tube O.D.	Part No.	Fitting Size	Tube O.D.	Part No.
2	1/8	2-Hand Preset Tool	10	5/8	10-Hand Preset Tool
4	1/4	4-Hand Preset Tool	12	3/4	12-Hand Preset Tool
5	5/16	5-Hand Preset Tool	14	7/8	14-Hand Preset Tool
6	3/8	6-Hand Preset Tool	16	1	16-Hand Preset Tool
8	1/2	8-Hand Preset Tool			

**How To Use:** Slide nut and ferrule(s) onto tube. Set tube into presetting tool, and bottom tube against shoulder tool. Finger tighten the nut and then tighten the nut 1 turn with a wrench. Remove tube from tool. Advance the nut so it is finger-tight. Advance the nut 1/2 turn. If torque rise is not felt in 1/4 turn, turn the nut to torque rise, loosen the nut to finger-tight, and makeup nut 1/2 turn.

\*For size 2 preset 5/8 turn in preset tool and make-up 1/4 turn in fitting body.



Parker Instrumentation Ferrule pre-setter (sizes 2 to 16)

### IPD Ferrule Hydraulic Presetting Tool Kit

An IPD Ferrule Hydraulic Presetting Tool Kit is available for making up 1/4" to 2" fractional size Parker A-LOK® or C-LOK® tube fittings. The unit, with Preset Head A or Head B is designed to preset ferrule(s) on tubing prior to proper assembly into a fitting. The Parker Preset Tool Kit contains a heavy duty accessory case, either Kit A Head or Kit B Head, an Enerpac Hydraulic Pump, Hose, Quick Connect, and the appropriate dies for the body and nut. This unit assures proper assembly, reduces installation time, and is easy to use by one person.

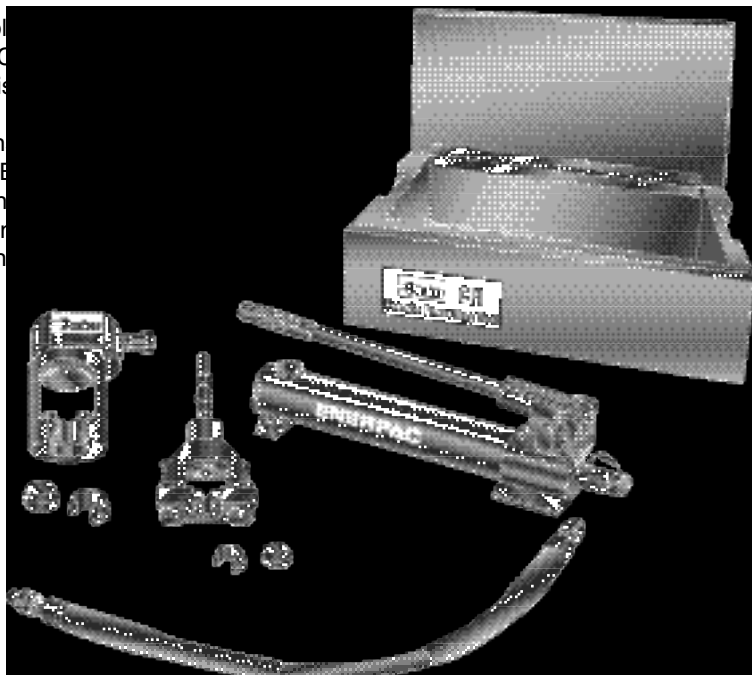

Ferrule Presetting Tool Kit

(Assembly Tools cont'd)

### Presetting CPI™/ A-LOK® Tube Fitting Ferrules Sizes 1/4" Through 1"

1. Insert "U-shaped" Nut Support ring into the back-up plate of the Hydraulic Ram as shown in Figure 2.
2. Assemble CPI™ nut, CPI™ Ferrule and body die onto tubing as shown in figure 1. Be sure that the tapered end of the Ferrule points toward the body die.
3. Insert Tube Assembly, (Figure 1) into Nut Support as shown in Figure 3.
4. Close the pressure relief valve on the side of the hand pump. Pump the hand pump until the ram reaches a positive stop. At this point an increase in resistance of the handle will be felt and the nut will bottom against the shoulder of the body die (Figure 4).
5. Release the hydraulic pressure by opening the relief valve on the side of the pump. The ram will automatically return to the original position.
6. The ferrule(s) is now pre-set on the tubing. Remove the pre-set assembly and pull the body die off the end of the tubing. If the body die does not pull off by hand, clamp on the outside of the body die and move the tubing back and forth while pulling. **Do not clamp or pull on the pre-set ferrule(s) as this could damage a sealing surface.**
7. Insert the pre-set assembly into a fitting body, and **make sure the ferrule seats in the fitting.** Tighten the nut on the fitting body until finger tight.
8. Tighten the nut with a wrench the additional amount shown in Table 1 for each connection size. **(If an increase in torque is not felt early in wrench makeup, the pre-set assembly was not properly seated.)** If this happens, tighten the nut with a wrench until the torque increase is felt. Then loosen nut to the finger tight position, tighten the nut the additional amount shown in Table 1.

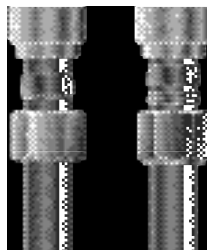

Figure 1

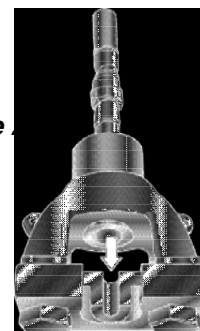

Figure 2

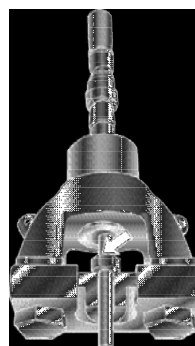

Figure 3

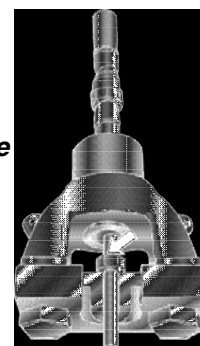

Figure 4

Size	4	6	8	10	12	14	16
Turns	1/2	1/2	1/2	1/2	1/2	1/2	1/2

Table 1

#### Ferrule Presetting Components

Threads	Size	Part Number		Hy-Fer-Set Kit Components	
		Body Die	Nut Die	Item	Part No.
1/4"	4	4 Body Die	4 Nut Die	Kit A Hydraulic Ram (size 4-16)	Hydraulic Ram
3/8"	6	6 Body Die	6 Nut Die	Hydraulic Hand Pump Hose Assembly Carrying Case	Enerpac Pump P-392 Hose Assembly w/ guards Carrying Case
1/2"	8	8 Body Die	8 Nut Die		
5/8"	10	10 Body Die	10 Nut Die		
3/4"	12	12 Body Die	12 Nut Die		
7/8"	14	14 Body Die	14 Nut Die		
1"	16	16 Body Die	16 Nut Die		16 Body Die Adapter

**Note:** To preset 1" ferrules with "B" Tool a size 16 Body Die Adapter must be used.

(Assembly Tools cont'd)

## Pre-setting the CPI™/A-LOK® Tube Fitting Ferrules Size 1-1/4", 1-1/2" and 2"

1. Insert "U-shaped" Nut Support ring into the back-up plate of the Hydraulic Ram as shown in Figure 2.
2. Assemble CPI™ nut, CPI™ Ferrule and body die onto tubing as shown in figure 1. Be sure that the tapered end of the Ferrule points toward the body die. (Silver plated nuts only - a thin coat of Permatex anti-seize lubricant is recommended on the nut threads and back collars.)
3. Insert Tube Assembly, (Figure 1) into Nut Support as shown in Figure 3.
4. Close the pressure relief valve on the side of the hand pump. Pump the hand pump until the ram reaches a positive stop. At this point an increase in resistance of the handle will be felt and the nut will bottom against the shoulder of the body die (Figure 4).
5. Release the hydraulic pressure by opening the relief valve on the side of the pump. The ram will automatically return to the original position.
6. The ferrule(s) is now pre-set on the tubing. Remove the pre-set assembly and pull the body die off the end of the tubing. (If the body die does not pull off by hand, clamp on the outside of the body die and move the tubing back and forth while pulling. Do not clamp or pull on the pre-set ferrule(s) as this could damage a sealing surface.
7. Insert the pre-set assembly into a fitting body, and make sure the ferrule seats in the fitting. Tighten the nut on the fitting body until finger tight.
8. Tighten the nut with a wrench the additional amount shown in Table 2 for each connection size. (If an increase in torque is not felt early in wrench makeup, the pre-set assembly was not properly seated.) If this happens, tighten the nut with a wrench until the torque increase is felt. Then loosen the nut to the finger-tight position, tighten the nut the additional amount shown in Table 2.

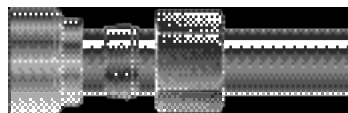

Figure 1

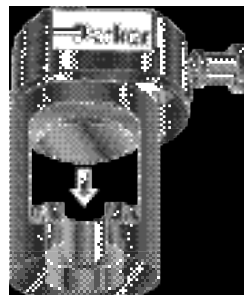

Figure 2

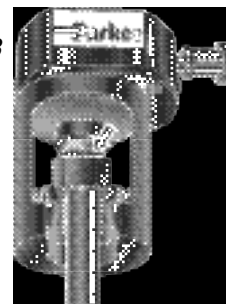

Figure 3

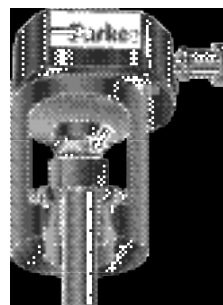

Figure 4

Size	20	24	32
Turns	5/8	5/8	3/4

Table 2

Part Number				Hy-Fer-Set Kit Components	
Tube O.D.	Size	Body Die	Nut Die	Item	Part Number
1-1/4"	20	20 Body Die	20 Nut Die	Kit B Hydraulic Ram (size 20-32)	Hyferset Body Assembly
1-1/2"	24	24 Body Die	24 Nut Die		
2"	32	32 Body Die	32 Nut Die		

Tube O.D.	"L"
1/4"	2"
3/8"	2-1/8"
1/2"	2-3/8"
5/8"	2-3/8"
3/4"	2-3/8"
7/8"	2-5/8"
1"	2-5/8"
1-1/4"	3"
1-1/2"	3-3/8"
2"	4-1/4"

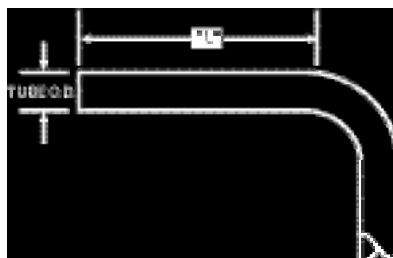

**Note:** You will need a **minimum straight length** of tubing ahead of any bend to fit into the pre-setting tool. See the "L" dimension in the chart for each tube O.D. size.



(Assembly Tools cont'd)

### The Parker P32 Rotary Wrench Size 1-1/4" thru 2"

The patent pending rotary wrench assembles and disassembles large size CPI™ and A-LOK® fittings in place in the field safely and effortlessly. The Rotary Wrench reduces long-term maintenance costs.

To reach the stage of assembly, follow these steps:

1. Pin reaction pad "F" to rotary wrench.
2. Open outer and inner rotary wrench hinges by loosening (2) cap screws.
3. Select proper split insert (20-24-32) to fit tube nut hex. Place split insert in rotary wrench head. Make certain drive teeth mesh.
4. Re-tighten inner, then outer cap screws to secure rotary wrench head and hex insert.
5. Position rotary wrench's hex insert on tube fitting nut.
6. Insert properly prepared tubing into tube fitting. Make certain to feel tubing bottom against stop in fitting body. Finger-tighten the nut and ferrule assembly. This eliminates the need for hydraulic pre-setting and hand wrench tightening. No bulky wrenches to create safety hazards. (Silver plated nuts only - a thin coat of Permatex anti-seize lubricant is recommended on the nut threads and back collars.)
7. **Use the ratcheting action of the PAK-32 Rotary Wrench to find "wrench tight" prior to assembly. By hand, use the rotary wrench to draw the nut and ferrule(s) to their proper position by "wrench" tightening the assembly until a sharp rise in torque is felt.**
8. Place hex wrench in "tighten" slot of reaction pad "F", and secure open end to tube body hex.
9. Mark nut and body hex to indicate starting point
10. Press advance button on remote control and release after each 18° split insert rotation. Repeat sequence until fitting is correctly assembled to 1-1/2 turns.

**Note:**

For

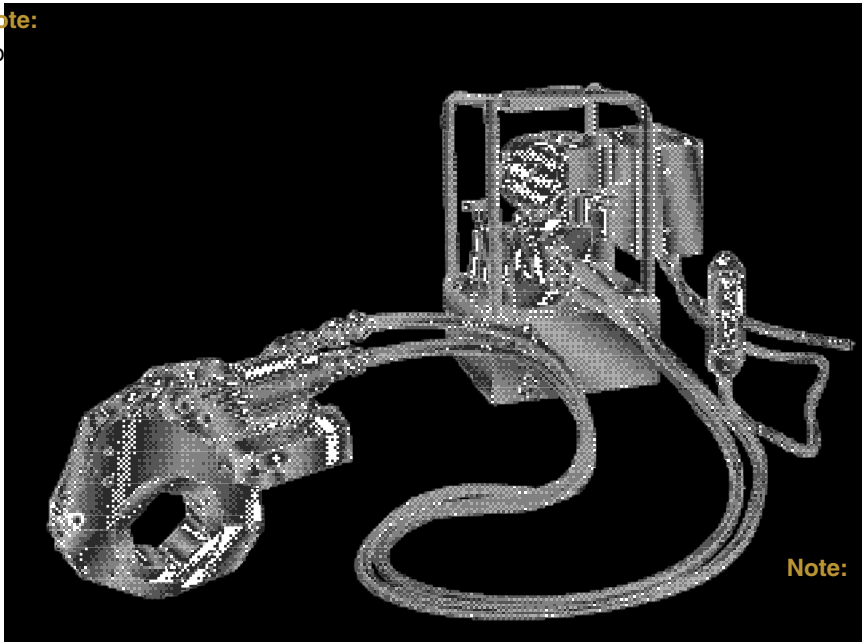

**Note:** Customer Power Supply

**Alignment of marks on nut and body.**

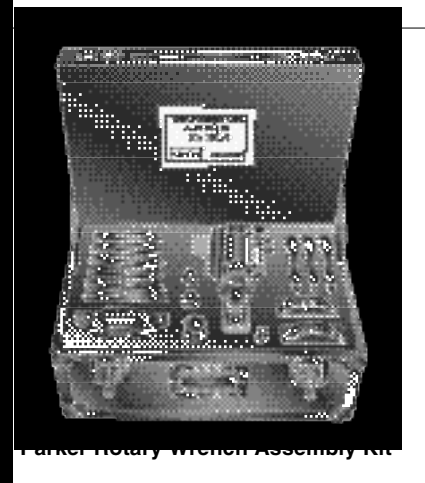

**Note:** You will need a **minimum straight length** ahead of any bend to fit into the pre-set. See the "L" dimension in the chart for each tube O.D. size.

Part Number				Hy-Fer-Set Kit Components
Threads	Size	Body Die	Nut Die	Item
1-1/4"	20	20 Body Die	Size 20 Nut Die	Kit B Hydraulic Ram (size 20-32)
1-1/2"	24	24 Body Die	Size 24 Nut Die	
2"	32	32 Body Die	Size 32 Nut Die	

Tube O.D.	"L"
1-1/4"	3"
1-1/2"	3-3/8"
2"	4-1/4"

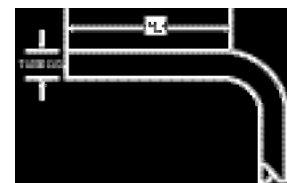

Size	20	24	32
Turns	5/8	5/8	3/4

**Table 2**

## Gaugeability Tools

### Tube Marker

Put burnish marks on the tubing quickly and accurately with this easy-to-use tube marker. Also used to check the burnish mark position. (Good for the life of the fitting.)

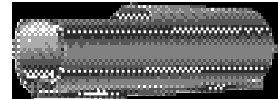

Tube Marker

### Inspection Gauges

This handy gauge does double duty. Use the No-Go portion (on one end) to check the tube insertion depth. Use the other end to check the space between the nut and body hex. (Proper initial make-up prevents the gauge from being inserted.)

Ensures proper tube depth insertion into the fitting body.

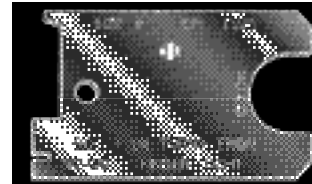

Inspection Gauge

Size	Tubing O.D.
2	1/8"
4	1/4"
6	3/8"
8	1/2"
10	5/8"
12	3/4"
14	7/8"
16	1"

SIZE		SIZE	
IN	MET	IN	MET
4"	16	4"	16
6"	12	6"	12
8"	18	8"	18
12"	25	12"	25
16"		16"	

This compact C-Ring gauge is for inch and metric sizes. Effectively checks the gap dimensions for proper initial make-up. Can be combined on a key ring for easy handling.

For more information on Gaugeability Tools, see page 17 - Assembly, Remake, and Gaugeability Instructions



Gap Gauge

## Technical Information

### Introduction

As a leading supplier of these products, Parker has recognized the need for thorough training of installation and maintenance technicians to help prevent these incidents and their often costly consequences.

### Instrumentation Tube Fitting Video Training Program

*"A complete training program for proper selection, preparation, assembly and installation."*

**The Parker Video Program includes:**

- Three Videotape Modules
- Leaders Guide
- Participant's Workbook

**The result is a complete, in-depth training program covering the following critical areas:**

- The Basics of Tubing System Fabrication
  - Tube selection factors; types of fittings
  - Tube preparation
  - Tube system installation
- Parker A-LOK® Fittings
  - Make and remake procedures
  - Proper use of tube marker and go/no go gauge
  - Port ends
- Parker CPI™ Fittings
  - Make and remake procedures
  - Proper use of tube marker and go/no go gauge
  - Proper use of hand pre-set and HyFerSet tools
  - Port ends

### Parker Hannifin Tube Fabrication Safety Seminar

Parker provides "hands on" safety seminars for the proper selection, preparation, tube bending and instrumentation fitting make and remake procedures.

**Features:**

- Factory trained field sales force and local distributor sales force for on-site seminars.
- CD Rom, (Powerpoint or slide presentation(s) for customer tailored safety seminars.
- Hands-on, interactive format.
- In-depth coverage of a wide range of instrumentation fitting concerns and effective procedures for system installation.
- Group or individual instruction.
- Detailed Tube Fabrication named for participants.

(Technical Information cont'd)

## Instrument Tubing Selection Guide

Parker's instrument tube fittings have been designed to work in a wide variety of applications that demand the utmost in product performance.

Although Parker's instrument tube fittings have been engineered and manufactured to consistently provide this level of reliability, no system's integrity is complete without considering the critical link, **tubing**.

This booklet is intended to assist the designer to properly select and order quality tubing.

Proper tube selection and installation, we believe, are key ingredients in building leak-free, reliable tubing systems.

### General Selection Criteria

The most important consideration in the selection of suitable tubing for any application is the compatibility of the tubing material with the media to be contained. Table 1 lists common materials and their associated general application. Table 1 also lists the maximum and minimum operating temperature for the various tubing materials.

In addition, Parker instrument fittings are designed to work on like materials. Stainless steel fittings should be used only with stainless steel tubing, aluminum fittings with aluminum tubing, etc. The practice of mixing materials is strongly discouraged. The only exception is brass fittings with copper tubing.

Dissimilar materials in contact may be susceptible to galvanic corrosion. Further, different materials have different levels of hardness, and can adversely affect the fittings ability to seal on the tubing.

**Table 1**

TUBING MATERIAL	GENERAL APPLICATION	RECOMMENDED TEMPERATURE RANGE
Stainless Steel	High Pressure, High Temperature, Generally Corrosive Media	-425°F to 1200°F <sup>1</sup> (-255°C to 650°C)
Carbon Steel	High Pressure, High Temperature Oil, Air, Some Specialty Chemicals	-20°F to 800°F <sup>2</sup> (-29°C to 425°C)
Copper	Low Temperature, Low Pressure Water, Oil, Air	-40°F to 400°F (-40°C to 205°C)
Aluminum	Low Temperature, Low Pressure Water, Oil, Air, Some Specialty Chemicals	-40°F to 400°F (-40°C to 205°C)
Monel 400™	Recommended for Sour Gas Applications. Well Suited for Marine and General Chemical Processing Applications	-325°F to 800°F (-198°C to 425°C)
Alloy C276	Excellent Corrosion Resistance to Both Oxidizing And Reducing Media and Excellent Resistance to Localized Corrosion Attack	-325°F to 1000°F (-198°C to 535°C)
Carpenter 20™	Applications Requiring Resistance to Stress Corrosion Cracking in Extreme Conditions	-325°F to 800°F (-198°C to 425°C)
Alloy 600	Recommended for High Temperature Applications With Generally Corrosive Media	-205° F to 1200°F (-130°C to 650°C)
Titanium	Resistant to Many Natural Environments such as Sea Water, Body Fluids and Salt Solutions	-75°F to 600°F (-59°C to 315°C)

Carpenter 20 is a trademark of Carpenter Technology Corporation. Monel 400 is a trademark of International Nickel.

<sup>1</sup> For operating temperatures above 800°F (425°C), consideration should be given to media. 300 Series Stainless Steels are susceptible to carbide precipitation which may lead to intergranular corrosion at elevated temperatures.

<sup>2</sup> Consideration should be given to maximum temperature ratings if fittings and/or tubing are coated or plated.

All temperature ratings based on maximum rated temperatures per ASME/ANSI B31-3 Chemical Plant and Petroleum Refinery Piping Code, 1987 Edition. The information listed in Table 1 is general in scope. For specific applications, please contact Parker's Instrumentation Products Division, Product Engineering Department (256) 881-2040.

(Technical Information cont'd)

## Gas Service

Special care must be taken when selecting tubing for gas service. In order to achieve a gas-tight seal, ferrules in instrument fittings must seal any surface imperfections. This is accomplished by the ferrules penetrating the surface of the tubing. Penetration can only be achieved if the tubing provides radial resistance and if the tubing material is softer than the ferrules.

Thick walled tubing helps to provide resistance. Tables 2-7 indicate the minimum acceptable wall thickness for various materials in gas service. The ratings in white indicate combination of diameter and wall thickness which are suitable for gas service.

Acceptable tubing hardness for general application is listed in Table 9. These values are the maximum allowed by ASTM. For gas service, better results can be obtained by using tubing well below this maximum hardness. For example, a desirable hardness of 80 Rb is suitable for stainless steel. The maximum allowed by ASTM is 90 Rb.

## System Pressure

The system operating pressure is another important factor in determining the type, and more importantly, the size of tubing to be used. In general, high pressure installations require strong materials such as steel or stainless steel. Heavy walled softer tubing such as copper may be used if chemical compatibility exists with the media. However, the higher strength of steel or stainless steel permits the use of thinner tubes without reducing the ultimate rating of the system. In any event, tube fitting assemblies should never be pressurized beyond the recommended working pressure.

The following tables (2-7) list by material the maximum suggested working pressure of various tubing sizes. Acceptable tubing diameters and wall thicknesses are those for which a rating is listed. Combinations which do not have a pressure rating are not recommended for use with instrument fittings.

## MAXIMUM ALLOWABLE WORKING PRESSURE TABLES

<b>Table 2</b>		<b>316 or 304 STAINLESS STEEL (Seamless)</b>														
<b>Tube O.D. Size</b>	<b>WALL THICKNESS</b>															
	<b>.010</b>	<b>.012</b>	<b>.014</b>	<b>.016</b>	<b>.020</b>	<b>.028</b>	<b>.035</b>	<b>.049</b>	<b>.065</b>	<b>.083</b>	<b>.095</b>	<b>.109</b>	<b>.120</b>	<b>.134</b>	<b>.156</b>	<b>.188</b>
1/16	5600	6900	8200	9500	12100	16800										
1/8						8600	10900									
3/16						5500	7000	10300								
1/4						4000	5100	7500	10300							
5/16							4100	5900	8100							
3/8							3300	4800	6600							
1/2							2500	3500	4800	6300						
5/8								3000	4000	5200	6100					
3/4								2400	3300	4300	5000	5800				
7/8								2100	2800	3600	4200	4900				
1									2400	3200	3700	4200	4700			
1-1/4										2500	2900	3300	3700	4100	4900	
1-1/2											2400	2700	3000	3400	4000	4500
2												2000	2200	2500	2900	3200

(Technical Information cont'd)

<b>Table 3</b>		<b>316 or 304 STAINLESS STEEL (Welded)</b>														
<b>Tube O.D. Size</b>	<b>WALL THICKNESS</b>															
	<b>.010</b>	<b>.012</b>	<b>.014</b>	<b>.016</b>	<b>.020</b>	<b>.028</b>	<b>.035</b>	<b>.049</b>	<b>.065</b>	<b>.083</b>	<b>.095</b>	<b>.109</b>	<b>.120</b>	<b>.134</b>	<b>.156</b>	<b>.188</b>
1/16	4800	5900	7000	8100	10300	14300										
1/8						7300	9300									
3/16						4700	6000	8700								
1/4						3400	4400	6400	8700							
5/16							3400	5000	6900							
3/8							2800	4100	5600							
1/2							2100	3000	4100	5300						
5/8								2500	3400	4500	5200					
3/4								2100	2800	3700	4200	4900				
7/8								1800	2400	3100	3600	4200				
1									2100	2700	3100	3600	4000			
1-1/4									2100	2400	2800	3100	3500	4200		
1-1/2										2000	2300	2600	2900	3400	4200	
2											1700	1900	2100	2500	3000	

<b>Table 4</b>		<b>CARBON STEEL (Seamless)</b>										
<b>Tube O.D. Size</b>	<b>WALL THICKNESS</b>											
	<b>.028</b>	<b>.035</b>	<b>.049</b>	<b>.065</b>	<b>.083</b>	<b>.095</b>	<b>.109</b>	<b>.120</b>	<b>.134</b>	<b>.148</b>	<b>.165</b>	<b>.180</b>
1/8	8100	10300										
3/16	5200	6700	9700									
1/4	3800	4900	7100	9700								
5/16		3800	5500	7700								
3/8		3100	4500	6200								
1/2		2300	3300	4500	6000							
5/8		1800	2600	3500	4600	5400						
3/4			2200	2900	3800	4400	5100					
7/8			1800	2500	3200	3700	4300					
1			1600	2100	2800	3200	3700	4100				
1-1/4				1700	2200	2500	2900	3200	3700	4100	4600	5100

<b>Table 5</b>		<b>COPPER (Seamless)</b>									
<b>Tube O.D. Size</b>	<b>WALL THICKNESS</b>										
	<b>.010</b>	<b>.020</b>	<b>.028</b>	<b>.035</b>	<b>.049</b>	<b>.065</b>	<b>.083</b>	<b>.095</b>	<b>.109</b>	<b>.120</b>	
1/16	1700	3800	5400	6000							
1/8			2800	3600							
3/16			1800	2300	3500						
1/4				1700	2600	3500					
5/16				1300	2000	2800					
3/8				1100	1600	2300					
1/2				800	1200	1600	2200				
5/8					900	1300	1700	2000			
3/4					800	1000	1400	1600	1900		
7/8					600	900	1100	1300	1600		
1					600	800	1000	1200	1400	1500	

<b>Table 6</b>		<b>ALUMINUM (Seamless)</b>				
<b>Tube O.D. Size</b>	<b>WALL THICKNESS</b>					
	<b>.035</b>	<b>.049</b>	<b>.065</b>	<b>.083</b>	<b>.095</b>	
1/8	8700					
3/16	5600	8100				
1/4	4100	5900				
15/16	3200	4600				
3/8	2600	3800				
1/2	1900	2800	3800			
5/8	1500	2200	2900			
3/4		1800	2400	3200		
7/8		1500	2100	2700		
1		1300	1800	2300	2700	

(Technical Information cont'd)

Table 7		MONEL 400 (Seamless)									
Tube O.D. Size	WALL THICKNESS										
	.010	.020	.028	.035	.049	.065	.083	.095	.109	.120	
1/16	5900	12600	17000								
1/8			8600	11000							
3/16			5500	7100	10300						
1/4			4000	5100	7500	10300					
5/16				4000	5900	8100					
3/8				3300	4800	6600					
1/2				2300	3300	4500	5900				
5/8					2800	3700	4900	5700			
3/4					2300	3100	4000	4600	5400		
1						2300	2900	3400	3900	4400	

- Note:**
- All working pressures have been calculated using the maximum allowable stress levels in accordance with ANSI B31.3, Chemical Plant and Petroleum Refinery Piping Code, 1987 Edition
  - All Calculations are based on maximum outside diameter and minimum wall thickness
  - All working pressures are at ambient (72°F or 22°C) temperature.

## System Temperature

Operating temperature is another factor in determining the proper tubing material. Copper and aluminum tubing are suitable for low temperature media. Stainless steel and carbon steel tubing are suitable for higher temperature media. Special alloys such as Alloy 600 are recommended for extremely high temperatures (see Table 1). Table 8 lists derating factors which should be applied to the working pressures listed in Tables 2-7 for elevated temperature conditions. Simply locate the correct factor in Table 8 and multiply this by the appropriate value in Tables 2-7 for the elevated temperature working pressure.

Table 8		Temperature Derating Factors					
Temperature °F	°C	Copper	Aluminum	.316SS	304SS	Steel	Monel
							400
100	(38)	1.00	1.00	1.00	1.00	1.00	1.00
200	(93)	0.80	1.00	1.00	1.00	.96	.88
300	(149)	0.78	0.81	1.00	1.00	.90	.82
400	(204)	0.50	0.40	.97	.94	.86	.79
500	(260)			.90	.88	.82	.79
600	(316)			.85	.82	.77	.79
700	(371)			.82	.80	.73	.79
800	(427)			.80	.76	.59	.76
900	(486)			.78	.73		
1000	(538)			.77	.69		
1100	(593)			.62	.49		
1200	(649)			.37	.30		

**Example:** 1/2 inch x .49 wall seamless stainless steel tubing has a working pressure of 3500 PSI @ room temperature. If the system were to operate @ 800°F (425°C), a factor of 80% (or .80) would apply (see Table 8 above) and the "at temperature" system pressure would be 35000 PSI x .80 = 2800 PSI.

(Technical Information cont'd)

## Hand Bender Capacity Guide — Inch Sizes

Part No.	Type of Bender	Size	Tube O. D. (in.)	Radius to Tube Centerline (in.)	Min. Wall Without Flattening (in.)	Recommended Maximum Wall Thickness	
						Copper Aluminum	Steel, Stainless Steel (in.)
2-2829S	Medium Duty	2	1/8	7/16	0.012	Any	0.032
3-2829S	Medium Duty	3	3/16	9/16	0.020	Any	0.032
4-2829S	Medium Duty	4	1/4	9/16	0.028	Any	0.083
5-2829S	Medium Duty	5	5/16	15/16	0.032	Any	0.083
6-2829S	Medium Duty	6	3/8	15/16	0.032	Any	0.083
8-2829S	Medium Duty	8	1/2	1 1/2	0.042	Any	0.083
10-2829S	Medium Duty	10	5/8	2 1/2	0.042	Any	0.049
12-2829S	Medium Duty	12	3/4	3	0.049	Any	0.065
10-2829	Ratchet	10	5/8	3	0.042	Any	0.049
12-2829	Ratchet	12	3/4	3 3/4	0.049	Any	0.065
14-2829	Ratchet	14	7/8	3 3/4	0.049	Any	0.065
16-2829	Light Duty	16	1	3 1/2	0.065	Any	Not Recommended

**Table N2**  
Hand Tube Bender — Inch Sizes

## Capacity Guide — Metric Sizes

Part No.	Type of Bender	Tube O. D. (mm)	Radius to Tube Centerline (mm)	Min. Tube Wall Thickness (mm)	Recommended Maximum Wall Thickness (mm)	
					Copper Aluminum	Steel, Stainless Steel
2829-5mm	Medium Duty	5	14.3	0.5	Any	1.0
2829-6mm	Medium Duty	6	14.3	1.0	Any	1.5
2829-8mm	Medium Duty	8	23.8	1.0	Any	1.5
2829-10mm	Medium Duty	10	23.8	1.0	Any	2.0
2829-12mm	Medium Duty	12	38.1	1.0	Any	2.0
2829-14mm	Medium Duty	14	38.1	1.0	Any	2.0

**Table N3**  
Hand Tube Bender — Metric Sizes

## Hand Crank & Hydraulic Tube Bender Capacity Guides

All benders listed in Table N4 are capable of bending 1/2" OD and under fully annealed steel and stainless steel tubing with no limit on wall thickness. For HARD copper and HIGH STRENGTH aluminum, use the wall thickness shown for stainless steel. Observe that VERY HARD materials may not be ductile enough to bend without fracture.

## Hand Crank & Hydraulic Bender Capacity Guide — Inch Sizes

Tube O. D.	Material	Tube Wall Thickness (Inches)											
		0.035	0.049	0.058	0.065	0.072	0.083	0.095	0.109	0.12	0.134	0.156	0.188
Bender Code*													
3/4"	S	ABCD	ABCD	ABCD	ABCD	BCD	BCD	BCD	BCD	BCD	BCD	BCD	BCD
	SS	ABCD	ABCD	BCD	BCD	BCD	BCD	BCD	BCD	BCD	BCD	BCD	BCD
1"	S	BCD	BCD	BCD	BCD	BCD	BCD	BCD	BCD	BCD	BCD	BCD	BCD
	SS	BCD	BCD	BCD	BCD	BCD	BCD	BCD	BCD	BCD	BCD	D	D
1 1/4"	S	BCD	BCD	BCD	BCD	BCD	BCD	D	D	D	D	D	D
	SS	BCD	BCD	BCD	BCD	BCD	D	D	D	D	D	D	D
1 1/2"	S	CD	CD	CD	CD	CD	D	D	D	D	D	D	D
	SS	CD	CD	D	D	D	D	D	D	D	D	D	D
2"	S	D	D	D	D	D	D	D	D	D	D	D	D
	SS	D	D	D	D	D	D	D	D	D	—	—	—

\*Codes: (A) Model 412 — Tubing (1/4" thru 3/4") — Worm & Gear — Rated Torque 2700 in. lbs.  
 (B) Model 420 — Tubing (1/4" thru 1 1/4") — Worm & Gear — Rated Torque 11000 in. lbs.  
 (C) Model 424 — Tubing (1/4" thru 1 1/2") — Worm & Gear — Rated Torque 11000 in. lbs.  
 (D) Model HB 632 — Tubing (3/8" thru 2") — Hydraulic — Rated Torque 52000 in. lbs.

**Table N4 — Hand Crank and Hydraulic Tube Benders Maximum Capacity Guide – Inch Sizes**

(Technical Information cont'd)

## Hand Crank & Hydraulic Bender Capacity Guide — Metric Sizes

Tube O.D. (mm)	Material	Tube Wall Thickness (mm)						
		1.5	2	2.5	3	3.5	4	5
		Bender Code*						
18	S	ABCD	ABCD	ABCD	ABCD	BCD	BCD	D
	SS	BCD	BCD	BCD	BCD	BCD	BCD	D
20	S	ABCD	ABCD	ABCD	BCD	BCD	BCD	D
	SS	BCD	BCD	BCD	BCD	BCD	BCD	D
22	S	BCD	BCD	BCD	BCD	BCD	BCD	D
	SS	BCD	BCD	BCD	BCD	BCD	D	D
25	S	BCD	BCD	BCD	BCD	BCD	D	D
	SS	BCD	BCD	BCD	BCD	D	D	D
28	S	BCD	BCD	BCD	BCD	D	D	D
	SS	BCD	BCD	D	D	D	D	D
30	S	BCD	BCD	BCD	BCD	D	D	D
	SS	BCD	BCD	D	D	D	D	D
32	S	BCD	BCD	D	D	D	D	D
	SS	BCD	D	D	D	D	D	D
38	S	CD	D	D	D	D	D	D
	SS	D	D	D	D	D	D	D

**Table N5 — Hand Crank and Hydraulic Tube Benders  
Maximum Capacity Guide – Metric Sizes**

\*Codes: (A) Model 412 — Tubing (6mm through 20mm)  
 (B) Model 420 — Tubing (6mm through 32mm)  
 (C) Model 424 — Tubing (6mm through 38mm)  
 (D) Model HB 632 — Tubing (10mm through 38mm)



## Assembly, Remake & Gaugeability Instructions

### Assembly and Remake Instructions

1. Parker instrument tube fittings are sold completely assembled and ready for immediate use. Simply insert the tube as illustrated until it bottoms in the fitting body. (If the fitting is disassembled, note that the small tapered end of the ferrule(s) go into the fitting body.)
2. Tighten nut finger tight. Then tighten nut with wrench an additional 1-1/4 turns indicated below. Hold fitting body with a second wrench to prevent body from turning. It is helpful to mark the nut to facilitate counting the number of turns.

For maximum number of remakes, mark the fitting and nut before disassembly. Before retightening, make sure the assembly has been inserted into the fitting until the ferrule seats in the fitting. Retighten the nut by hand. Rotate the nut with a wrench to the original position as indicated by the previous marks lining up. (A noticeable increase in mechanical resistance will be felt indicating the ferrule is being re-sprung into sealing position.)

Then snug the nut 1/12 (1/2 hex flat) as shown from A to B, past the original position.

### Gaugeability Assembly Instructions

Using the Parker Tube Marker and Inspection Gauges, you can make precise, accurate tubing connections-even though you can't see inside the fitting. Here's how:

1. Put tube marker completely on to tube.
2. Press marking arm against tube and rotate marker 360° - to leave a burnish mark around the tube.
3. Check burnish mark position by butting flat (A) on marker against end of tube. Burnish marks is in correct position if it lines up with end of tube marker (B).
4. Now insert the tube into the fitting until tube bottoms inside. (If the fitting is disassembled, note that the small tapered end of the ferrule goes into the fitting body.) Tighten nut finger-tight.
5. From "finger-tight" position, wrench 1-1/4 turns for 1/4" to 1" size fittings (1/16", 1/8" and 3/16" size tube fittings only wrench 3/4 turn from finger tight position). Hold fitting body hex with second wrench to prevent body from turning as you tighten. It is a good idea to mark the nut (scribe or ink) to help you count the turns.
6. Now select the proper size Inspection gauge and try to place it, as shown, between the nut and the body hex. If gauge DOES NOT FIT AT ANY POINT between them, you have correctly tightened the nut. If you can slip the gauge into the space, the fitting is not properly made up. And you must repeat the assembly procedure.
7. Then place the proper size Inspection gauge against the fitting as shown, pressing it against the hex face. Burnish mark on tube should line up within gauge band. If it does, you know the tube band -either above or below it-the tube is incorrectly inserted, and you must repeat the marking and assembly procedures.
8. To get the maximum number of remakes, mark fitting body and nut (A-A) before disassembly. Before retightening, make sure the assembly has been inserted into the fitting until the ferrule(s) seats in the body. Retighten the nut by hand. Rotate the nut with a wrench to the original position as indicated by the previous marks lining up. (A noticeable increase in mechanical resistance will be felt indicating the ferrule(s) is being re-sprung into sealing position.) Then snug the nut 1/12 turn (1/2 hex flat) as shown from A to B, past the original position.

**Note:** The above instructions, if followed correctly and carefully, should provide suitable installation. However, leak tightness may be affected by other installation problems, such as inadvertent scoring of tubing, or by material problems.

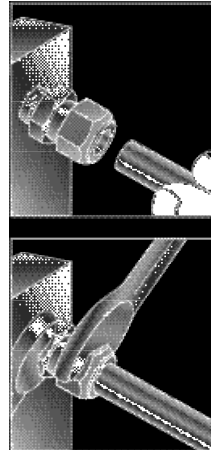

SIZE 1 thru 3  
(1/16" - 3/16")



Only 3/4 Turn from finger tight is necessary to seal and will result in additional remakes of the fitting.

SIZE 4 thru 16  
(1/4" - 1")



1-1/4 Turns from Finger Tight

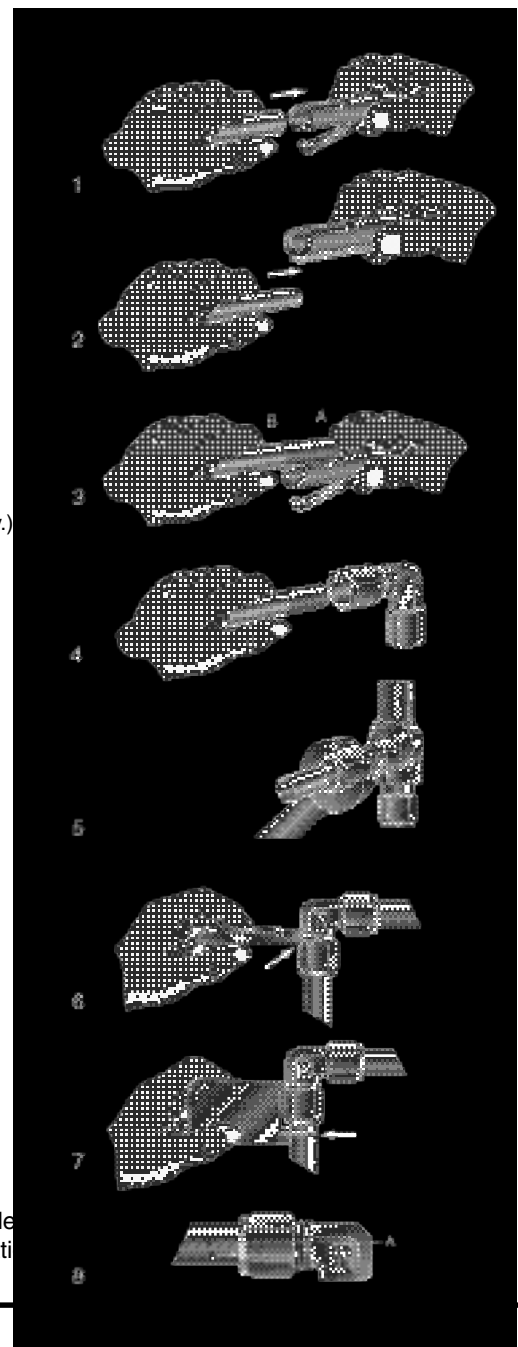

## TUBE FITTING AND TUBE FABRICATION EQUIPMENT AVAILABLE FROM PARKER HANNIFIN'S TUBE FITTINGS DIVISION

### THREAD IDENTIFICATION KIT

PG. 19



THREAD IDENTIFICATION KIT



PORTBOARDS

### SEALANTS, LUBRICANTS & CLEANERS

PG. 19



TEFLON TAPE



PERMATEX ANTI-SEIZE LUBRICANT



LOCTITE 7649 PRIMER N



LOCTITE THREAD SEALANT 565



LOCTITE THREAD SEALANT 545



LOCTITE THREADLOCKER 242



LOCTITE THREADLOCKER 271



PERMATEX HAND CLEANER



FAST ORANGE WIPES

## PARKER HANNIFIN CORPORATION ALSO MANUFACTURES A WIDE RANGE OF TUBE FITTINGS AND TUBE FABRICATION EQUIPMENT INCLUDING:

### BENDERS



EXACTOL BENDERS 412, 420 & 424



RADIUS BLOCKS

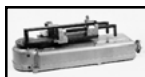

Hb 632 HYDRAULIC BENDER



BENDER TABLE (WITH LOCKING COASTERS)

### O-RING ASSEMBLY



O-RING INSTALLATION KIT



CAPTIVE O-RING TOOL

### CUTTING & DEBURRING TOOLS



CUT-OFF SAW



POWER DEBURR TOOL

### WRENCHES



PAR-LOK WRENCH

FOR MORE INFORMATION ON THESE PRODUCTS, PLEASE CALL  
THE TUBE FITTINGS DIVISION AT (614) 279-7070.

## Thread Identification

### Thread Identification Kit

**Part No. MIK-1**

Metric thread identification kit contains an illustrated booklet containing information about metric and multi-standard fittings and ports. The kit also contains a U.S.A. thread gauge for identifying eight different thread and pitch angles: an international thread gauge for identifying metric, British and Japanese threads, both taper and parallel; and a stainless steel inside/outside caliper with dual inch/millimeter scales.



**Thread Identification Kit**

## Sealants

### Lubricants and Sealants

Lubricants act as friction reducers to ease assembly and prevent galling, corrosion and seizing of components. Permatex Anti-Seize lubricants are recommended for use with assembly of stainless steel threaded components where galling may be a problem.

#### Teflon\* Tape

1/2" x 520" spools

\*DuPont registered trademark. For use with male pipe threads.

**Part No.**

Teflon\* Tape



**Teflon\* Tape**

#### Permatex Anti-Seize Lubricant

Parker offers a highly refined blend of aluminum, copper and graphite lubricants that are used during assembly to prevent galling, corrosion and seizing in temperatures of -65°F to 1600°F. They also assure easier assembly. They are salt, corrosion and moisture resistant.

Applications: Stainless steel threads for reduced chance of galling.

Sizes available	Part No.
1 oz. tube .....	81343
8 oz. bottle .....	80078
8.5 oz. aerosol .....	81464



**Permatex Anti-Seize Lubricant**

#### Loctite 7649 Primer N

Loctite 7649 Primer N decreases the set-up time of Loctite threadlockers and increases breakaway torque on most fastener surfaces. It allows for cold weather application.

Applications: Use with Loctite threadlockers, thread sealants and retaining compounds.

Sizes available	Part No.
25 g aerosol .....	21347
4.5 oz. aerosol .....	21348



**Loctite 7649 Primer N**

(Sealants cont'd)

## Threadlocking and Sealing

Threadlockers perform by filling the space between threaded metal parts and hardening to form a tough, adhesive bond and seal. Threadlockers seal the threads against leakage and prevent rust and corrosion. Threadlockers can be used on fasteners. Some threadlockers require extra effort or special tools for removal.

Thread sealants seal and secure metal pipes and fittings by filling the space between the threaded metal parts. Thread sealants harden to prevent leakage caused by vibration loosening, tape shredding, solvent evaporation, damaged threads and temperature cycling.

Designed for low and high pressure applications, thread sealants seal quickly for on-line low pressure testing. When fully cured, they seal to the burst strength of most systems. Thread sealants are easily removed with basic hand tools. Thread sealants can be used on pipe thread fittings.

### Loctite Thread Sealant 565

Formulated specifically for metal tapered pipe thread fittings. PST 565 cures rapidly to provide immediate low pressure sealing. Its controlled lubricity prevents galling and it protects mated thread areas from rust and corrosion.

Application: Stainless steel tapered pipe threads

Sizes available	Part No.
6 ml tube .....	25117
36 ml tube .....	56521



Loctite Thread Sealant 565

### Loctite Thread Sealant 545

Designed for both hydraulic and pneumatic systems, 545 contains no fillers or particles which could contaminate system fluids, foul valves, or clog fine filters and screens.

Applications: Steel and brass tapered pipe threads

Sizes available	Part No.
.5 ml capsule .....	54505
50 ml bottle .....	54531



Loctite Thread Sealant 545

### Loctite Threadlocker 242

All-purpose, medium strength threadlocker is ideal for all nut and bolt applications. It eliminates the need for stocking expensive lock nuts and washers. Its other advantages include: locking and sealing while preventing parts from loosening during vibration, protecting threads from corrosion, and easy disassembly with hand tools.

Applications: All fastener applications.

*DO NOT USE THIS PRODUCT WITH PARKER TUBE FITTINGS. RECOMMENDED ONLY FOR FASTENER APPLICATIONS.*

Sizes available	Part No.
6 ml tube .....	24200
36 ml tube .....	24240



Loctite Threadlocker 242

(Sealants cont'd)

### Loctite High Strength Threadlocker 271

High strength threadlocker for heavy-duty applications is especially well-suited for permanently locking studs and press fits. It replaces set screws and snap rings and locks against vibration loosening.

Applications: Permanent fastener requirements. **DO NOT USE THIS PRODUCT WITH PARKER TUBE FITTINGS. RECOMMENDED ONLY FOR FASTENER APPLICATIONS.**

Sizes available	Part No.
6 ml tube .....	27100
36 ml tube .....	27140



Loctite High Strength Threadlocker 271

## Cleaners

Permatex Fast Orange waterless hand cleaners can be used to remove grease, grime, paint, adhesives and other soils your working hands get into. Fast Orange has added conditioners to prevent your hands from cracking and drying out.

### Permatex Fast Orange Hand Cleaner

Permatex Fast Orange is the #1 selling biodegradable, waterless petroleum solvent-free hand cleaner that contains no harsh chemicals, mineral oils or ammonia that can sting cuts and abrasions. Pure, fresh smelling natural citrus power does the cleaning. With aloe, lanolin, jojoba and now Corn Huskers Lotion® for added skin conditioning and protection, its smooth formula gently deep cleans the toughest dirt.

Applications: Clean-up of resins, oil, grease, tar, ink, epoxies, paint and various adhesives.

Sizes available	Part No.
15 oz. bottle .....	25116

Part Name	Part No.
Fast Orange Wipes (100 count) .....	25312
Permatex Fast Orange Cleaner in towel form, 100 count per bucket	



Permatex Fast Orange Hand Cleaner



Fast Orange Wipes

The items described in this document and other documents or descriptions provided by Parker Hannifin Corporation, its subsidiaries and its authorized distributors are hereby offered for sale at prices to be established by Parker Hannifin Corporation, its subsidiaries and its authorized distributors. This offer and its acceptance by any customer ("Buyer") shall be governed by all of the following Terms and Conditions. Buyer's order for any such items, when transmitted to Parker Hannifin Corporation, its subsidiary or an authorized distributor ("Seller") verbally or in writing, shall constitute acceptance of this offer.

**1. Terms and Conditions of Sale:** All descriptions, quotations, proposals, offers, acknowledgments, acceptances and sales of Seller's products are subject to and shall be governed exclusively by the terms and conditions stated herein. Buyer's acceptance of any offer to sell is limited to these terms and conditions. Any terms or conditions in addition to, or inconsistent with those stated herein, proposed by Buyer in any acceptance of an offer by Seller, are hereby objected to. No such additional, different or inconsistent terms and conditions shall become part of the contract between Buyer and Seller unless expressly accepted in writing by Seller. Seller's acceptance of any offer to purchase by Buyer is expressly conditional upon Buyer's assent to all the terms and conditions stated herein, including any terms in addition to or inconsistent with those contained in Buyer's offer. Acceptance of Seller's products shall in all events constitute such assent.

**2. Payment:** Payment shall be made by Buyer not 30 days from the date of delivery of the items purchased hereunder. Amounts not timely paid shall bear interest at the maximum rate permitted by law for each month or portion thereof that the Buyer is late in making payment. Any claims by Buyer for omissions or shortages in a shipment shall be waived unless Seller receives notice thereof within 30 days after Buyer's receipt of the shipment.

**3. Delivery:** Unless otherwise provided on the face hereof, delivery shall be made F.O.B. Seller's plant. Regardless of the method of delivery, however, risk of loss shall pass to Buyer upon Seller's delivery to a carrier. Any delivery dates shown are approximate only and Seller shall have no liability for any delays in delivery.

**4. Warranty:** Seller warrants that items sold hereunder shall be free from defects in material or workmanship. **THIS WARRANTY COMPRISES THE SOLE AND ENTIRE WARRANTY PERTAINING TO ITEMS PROVIDED HEREUNDER. SELLER MAKES NO OTHER WARRANTY, GUARANTEE, OR REPRESENTATION OF ANY KIND WHATSOEVER. ALL OTHER WARRANTIES, INCLUDING BUT NOT LIMITED TO, MERCHANTABILITY AND FITNESS FOR PURPOSE, WHETHER EXPRESS, IMPLIED, OR ARISING BY OPERATION OF LAW, TRADE USAGE, OR COURSE OF DEALING ARE HEREBY DISCLAIMED.**

**NOTWITHSTANDING THE FOREGOING, THERE ARE NO WARRANTIES WHATSOEVER ON ITEMS BUILT OR ACQUIRED WHOLLY OR PARTIALLY TO BUYER'S DESIGNS OR SPECIFICATIONS.**

**5. Limitation Of Remedy:** SELLER'S LIABILITY ARISING FROM OR IN ANY WAY CONNECTED WITH THE ITEMS SOLD OR THIS CONTRACT SHALL BE LIMITED EXCLUSIVELY TO REPAIR OR REPLACEMENT OF THE ITEMS SOLD, AT SELLER'S SOLE OPTION. IN NO EVENT SHALL SELLER BE LIABLE FOR ANY INCIDENTAL, CONSEQUENTIAL OR SPECIAL DAMAGES OF ANY KIND OR NATURE WHATSOEVER, INCLUDING BUT NOT LIMITED TO LOST PROFITS ARISING FROM OR IN ANY WAY CONNECTED WITH THIS AGREEMENT OR ITEMS SOLD HEREUNDER, WHETHER ALLEGED TO ARISE FROM BREACH OF CONTRACT, EXPRESS OR IMPLIED WARRANTY, OR IN TORT, INCLUDING WITHOUT LIMITATION, NEGLIGENCE, FAILURE TO WARN OR STRICT LIABILITY.

**6. Changes, Reschedules and Cancellations:** Buyer may request to modify the designs or specifications for the items sold hereunder as well as the quantities and delivery dates thereof, or may request to cancel all or part of this order, however, no such requested modification or cancellation shall become part of the contract between Buyer and Seller unless accepted by Seller in a written amendment to this Agreement. Acceptance of any such requested modification or cancellation shall be at Seller's discretion, and shall be upon such terms and conditions as Seller may require.

**7. Special Tooling:** A tooling charge may be imposed for any special tooling, including without limitation, dies, fixtures, molds and patterns, acquired to manufacture items sold pursuant to this contract. Such special tooling shall be and remain Seller's property notwithstanding payment of any charges by Buyer. In no event will Buyer acquire any interest in apparatus belonging to Seller which is utilized in the manufacture of the items sold hereunder, even if such apparatus has been specially converted or adapted for such manufacture and not withstanding any charges paid by Buyer. Unless otherwise agreed, Seller shall have the right to alter, discard or otherwise dispose of any special tooling or other property in its sole discretion at any time.

**8. Buyer's Property:** Any designs, tools, patterns, materials, drawings, confidential information or equipment furnished by Buyer or any other items which become Buyer's property, may be considered obsolete and may be destroyed by Seller after two (2) consecutive years have elapsed without Buyer placing an order for the items which are manufactured using such property. Seller shall not be responsible for any loss or damage to such property while it is in Seller's possession or control.

**9. Taxes:** Unless otherwise indicated on the face hereof, all prices and charges are exclusive of excise, sales, use, property, occupational or like taxes which may be imposed by any taxing authority upon the manufacture, sale or delivery of the items sold hereunder. If any such taxes must be paid by Seller or if Seller is liable for the collection of such tax, the amount thereof shall be in addition to the amounts for the items sold. Buyer agrees to pay all such taxes or to reimburse Seller therefor upon receipt of its invoice. If Buyer claims exemption from any sales, use or other tax imposed by any taxing authority, Buyer shall save Seller harmless from and against any such tax, together with any interest or penalties thereon which may be assessed if the items are held to be taxable.

**10. Indemnity For Infringement of Intellectual Property Rights:** Seller shall have no liability for infringement of any patents, trademarks, copyrights, trade dress, trade secrets or similar rights except as provided in this Part 10. Seller will defend and indemnify Buyer against allegations of infringement of U.S. Patents, U.S. Trademarks, copyrights, trade dress and trade secrets (hereinafter "Intellectual Property Rights"). Seller will defend at its expense and will pay the cost of any settlement or damages awarded in an action brought against Buyer based on an allegation that an item sold pursuant to this contract infringes the Intellectual Property Rights of a third party. Seller's obligation to defend and indemnify Buyer is contingent on Buyer notifying Seller within ten (10) days after Buyer becomes aware of such allegations of infringement, and Seller having sole control over the defense of any allegations or actions including all negotiations for settlement or compromise. If an item sold hereunder is subject to a claim that it infringes the Intellectual Property Rights of a third party, Seller may, at its sole expense and option, procure for Buyer the right to continue using said item, replace or modify said item so as to make it noninfringing, or offer to accept return of said item and return the purchase price less a reasonable allowance for depreciation. Notwithstanding the foregoing, Seller shall have no liability for claims of infringement based on information provided by Buyer, or directed to items delivered hereunder for which the designs are specified in whole or part by Buyer, or infringements resulting from the modification, combination or use in a system of any item sold hereunder. The foregoing provisions of this Part 10 shall constitute Seller's sole and exclusive liability and Buyer's sole and exclusive remedy for infringement of Intellectual Property Rights.

If a claim is based on information provided by Buyer or if the design for an item delivered hereunder is specified in whole or in part by Buyer, Buyer shall defend and indemnify Seller for all costs, expenses or judgments resulting from any claim that such item infringes any patent, trademark, copyright, trade dress, trade secret or any similar right.

**11. Force Majeure:** Seller does not assume the risk of and shall not be liable for delay or failure to perform any of Seller's obligations by reason of circumstances beyond the reasonable control of Seller (hereinafter "Events of Force Majeure"). Events of Force Majeure shall include without limitation, accidents, acts of God, strikes or labor disputes, acts, laws, rules or regulations of any government or government agency, fires, floods, delays or failures in delivery of carriers or suppliers, shortages of materials and any other cause beyond Seller's control.

**12. Entire Agreement/Governing Law:** The terms and conditions set forth herein, together with any amendments, modifications and any different terms or conditions expressly accepted by Seller in writing, shall constitute the entire Agreement concerning the items sold, and there are no oral or other representations or agreements which pertain thereto. This Agreement shall be governed in all respects by the law of the State of Ohio. No actions arising out of the sale of the items sold hereunder or this Agreement may be brought by either party more than two (2) years after the cause of action accrues.

11/98 P



**Parker Hannifin Corporation**  
 6035 Parkland Blvd.  
 Cleveland, Ohio 44124-4141  
 Telephone: (216) 896-3000  
 Fax: (216) 896-4000  
 www.parker.com

## Parker Hannifin Corporation

### About Parker Hannifin Corporation

Parker Hannifin is a leading global motion-control company dedicated to delivering premier customer service. A Fortune 500 corporation listed on the New York Stock Exchange (PH), our components and systems comprise over 1,400 product lines that control motion in some 1,000 industrial and aerospace markets. Parker is the only manufacturer to offer its customers a choice of hydraulic, pneumatic, and electromechanical motion-control solutions. Our Company has the largest distribution network in its field, with over 7,500 distributors serving nearly 400,000 customers worldwide.

### Parker's Charter

To be a leading worldwide manufacturer of components and systems for the builders and users of durable goods. More specifically, we will design, market and manufacture products controlling motion, flow and pressure. We will achieve profitable growth through premier customer service.

### Product Information

North American customers seeking product information, the location of a nearby distributor, or repair services will receive prompt attention by calling the Parker Product Information Center at our toll-free number: 1-800-C-PARKER (1-800-272-7537). In Europe, call 00800-C-PARKER-H (00800-2727-5374).

**The Aerospace Group** is a leader in the development, design, manufacture and servicing of control systems and components for aerospace and related high-technology markets, while achieving growth through premier customer service.



**The Climate & Industrial Controls Group** designs, manufactures and markets system-control and fluid-handling components and systems to refrigeration, air-conditioning and industrial customers worldwide.



**The Fluid Connectors Group** designs, manufactures and markets rigid and flexible connectors, and associated products used in pneumatic and fluid systems.



**The Seal Group** designs, manufactures and distributes industrial and commercial sealing devices and related products by providing superior quality and total customer satisfaction.



**The Hydraulics Group** designs, produces and markets a full spectrum of hydraulic components and systems to builders and users of industrial and mobile machinery and equipment.



**The Filtration Group** designs, manufactures and markets quality filtration and clarification products, providing customers with the best value, quality, technical support, and global availability.



**The Automation Group** is a leading supplier of pneumatic and electromechanical components and systems to automation customers worldwide.



**The Instrumentation Group** is a global leader in the design, manufacture and distribution of high-quality critical flow components for worldwide process instrumentation, ultra-high-purity, medical and analytical applications.



# CONNEXION

---



Parker Hannifin Corporation  
Instrumentation Products Division  
P.O. Box 400004-1504  
Huntsville, AL 35815-1504  
USA  
Phone: (256) 881-2040  
Fax: (256) 881-5730  
[www.parker.com/icd](http://www.parker.com/icd)